

# Galassia GAX 611 Specifications

- **1 x 90mm Waste with Basket Strainer Waste.**  
Capable of adaptation to take Waste Disposal Unit
- **Modern functional design**
- **Single bowl, single drainer format**
- **Extra large multi-purpose bowl**
- **Waste at rear of bowl**
- **3 colours of bespoke accessories available**

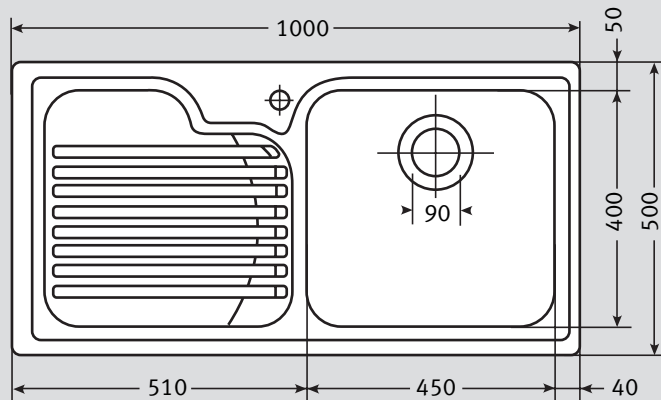

**Material:** 304 Austenitic 18/10 Stainless Steel

**Application:** Inset

**Bowl Size:** 450 x 400 x 190  
(Welded to frame)

**Drainer Format:** Left or right hand drainer available

**Cut-out Size:** 980 x 480 (cr=20)

**Colour:** Silk Stainless Steel

**Seal:** Sealing strip supplied

**Insulation:** Factory fitted black pads

**Heat Resistance:** Up to 300°C

**Earthing Point:** Utilise clip rail slots

**Cabinet Size:**

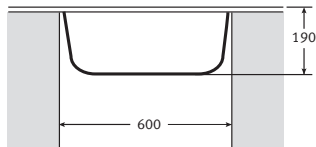

**Sink Profile:** Folded Edge

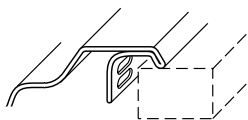

**Fixing Clips:**

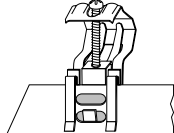

**Suggested Plumbing Kit:** 1 part

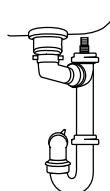

**Waste:** 1 x Lira 90mm Basket Strainer Waste with overflow

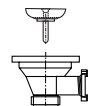

**Overflow:**



**Accessories Available:**



**Food Preparation Platter**  
Mahogany

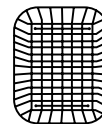

**Drainer Basket**  
Available in White, Almond or Brown

**Taps:** Any Franke tap can be utilised with this model\*.

\*Ceramic disc taps in certain installations or where there is a low head of water (below 4 metres) may not provide adequate flow rates. You are advised to check with your supplier.

Some taps may need bracing to avoid flexing of the sink ledge.

**Guarantee:** Franke sinks are guaranteed for 25 years against manufacturing defect. Franke taps are guaranteed against defective materials and workmanship for 1 year in relation to coatings and finishes, and 5 years in relation to moving parts. Franke will replace (and where appropriate repair) defective sinks. In relation to taps, Franke will where appropriate provide replacement parts for your taps or replace your taps. Any associated or ancillary costs to be incurred by you as a result of replacement of Franke sinks and taps under this guarantee shall in all cases be previously approved by Franke UK Limited.

This guarantee is in addition to and does not affect your statutory rights.